

INSTALLATION INSTRUCTIONS

CHAIN ROLLER SHADE

WITH MAXIUM-ALS SYSTEM

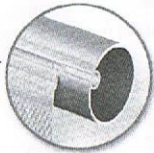

The Altex Lock System (ALS) is exclusive to Altex. Its main distinction is its totally safe lock system. The shade cloth is attached to a spline that slides into a groove, which secures the fabric to the roller and prevents detaching.

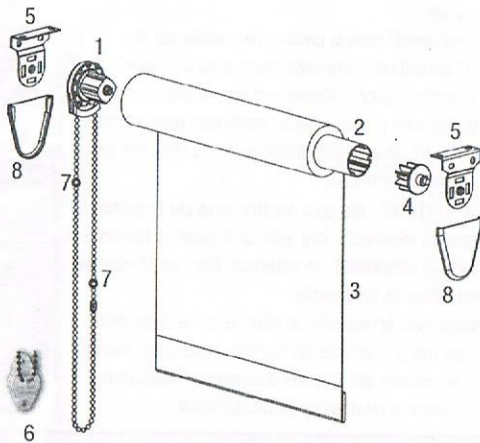

Your shade should include the following pieces:

- | | |
|--------------------------|----------------------------------|
| 1. Clutch | 5. Universal brackets (2) |
| 2. Tube | 6. Cord retainer |
| 3. Fabric | 7. Stoppers |
| 4. Spring loaded pin end | 8. Bracket covers (2) (optional) |

WARNING

Cords and bead chains can loop around a child's neck and STRANGLE.

- Always keep cords and bead chains out of children's reach.
- Move furniture away from cords and bead chains. Children can climb furniture to get to cords. For more safety information: 1-866-662-0666.



ALTEX
www.altex.ca

April 2013

MAGL_TRMA1(1304)

STEP 1

FIXING BRACKETS

- A- Check the width printed on the wrapper of your shade;
 B- Depending on the mounting (wall, ceiling or inside the window frame), mark the location where the brackets will be screwed;
 C- Screw in the brackets at the correct angle (brackets are universal. Each bracket can be used for the right and left sides).

IMPORTANT: Make sure that brackets are mounted level.

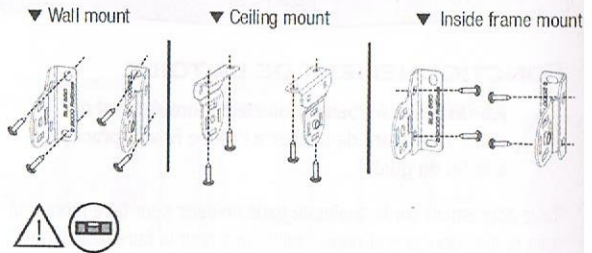

SHARING A BRACKET BETWEEN TWO SHADES (IF NECESSARY)

If sharing a bracket between two shades, bracket can only be shared by a clutch and a pin end, not clutch-to-clutch or pin end-to-pin end.

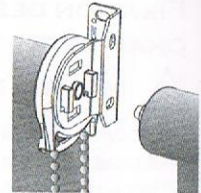

IMPORTANT: The lower part of the bracket (dark area on picture) must be considered as the center of the two shades.



STEP 2

INSTALL THE SHADE

IMPORTANT: You must respect the order of the two following steps.

- A- Put the spring loaded pin end into the round hole of the bracket;
 B- Insert the hook arms of the clutch straight into the two hook arm receiver holes of the brackets. Once the two hook arms are through the holes, gently pull down the clutch until the two hook arms have locked securely to the brackets.

STEP 3

INSTALL THE BRACKET COVERS (OPTIONAL)

Depending on the order, your packaging might contain covers. Bracket covers are slid over the brackets until snapped into position.

STEP 4

OPERATE THE SHADE

IMPORTANT: If needed, adjust the roll-up of your shade before going to *step 5* (see procedure at the end of this guide).

Pulling gently on the bead chain in one direction raises the shade cloth; pulling it in the other direction lowers it. Make sure that the fabric rolls-up straight.

STEP 5

ATTACH THE STOPPERS TO THE CHAIN

IMPORTANT: It is essential to attach the stoppers.

For plastic bead chain:

- A- Lower the shade to reach the window sill;
- B- Attach the stopper next to mechanism, on the front part of the chain. It will prevent the shade from being lowered below this point.

Take note that the first stopper which controls the roll-up of the shade is factory installed.

For stainless steel bead chain:

- A- Raise the shade to the maximum desired level;
- B- Attach the stopper without tightening it, near the mechanism, on the back part of the chain;
- C- Ensure that the shade stops at the desired level, then tighten the stopper using pliers;
- D- Lower the shade to the lowest desired level;
- E- Attach another stopper without tightening it, near the mechanism, on the front part of the chain;
- F- Ensure that the shade stops at the desired point, then tighten the stopper using pliers.

STEP 5

ATTACHMENT OF CORD RETAINER

The cord retainer reduces strangulation and tangle risks as well as limiting the access to the chain. Once the shade is installed in its brackets:

- A- Remove cord retainer from the plastic bag;
- B- Remove the rubber band that holds the chain (or the cord);
- C- Using the chain (or the cord), lower the shade to the ordered height;
- D- Move the cord retainer to the bottom of the chain (or the cord) by pressing and keeping pressure on the back of the cord retainer, where the spring is visible (see illustration 1); once it has reached the bottom of the chain (or the cord), release the pressure on the cord retainer;

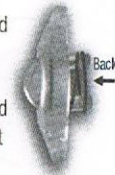

Illustration 1

- E- Position the cord retainer, where it will be fixed (on the wall or inside the window frame, as shown on illustration 2). Slightly pull the cord retainer down in order to stretch the chain (or the cord) to its maximum length then move it up 1/4" (0.75 cm). We recommend that the chain (or the cord) be parallel to the shade;

IMPORTANT: Do not create too much tension to the chain (or cord) to insure it moves freely into the cord retainer. Do not twist or tangle the chain (or the cord).

- F- Using the provided screws, solidly fasten the cord retainer to the wall or inside the window frame. If required, use the provided anchors in order to solidly fasten the installation;
- G- Remove the Warning label, if needed.



Illustration 2

ADJUST ROLL-UP

If needed, make the adjustment if your shade doesn't roll up straight.



- A- Make sure that brackets are mounted level, or the shade will roll crooked;

- B- If needed, remove the stopper on the front of the chain;

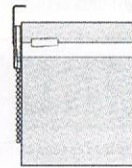
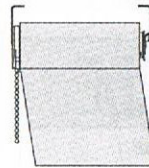

If shade veers toward the right, lower shade completely and place a piece of tape (multiple pieces may be necessary) as close to the left edge of the roller as possible.

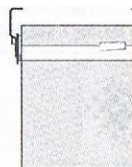
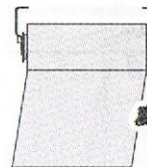

If shade veers toward the left, lower shade completely and place a piece of tape (multiple pieces may be necessary) as close to the right edge of the roller as possible.

- C- To attach stopper to chain, please refer to step 5.

INSTALLATION INSTRUCTIONS

WOOD VALANCE

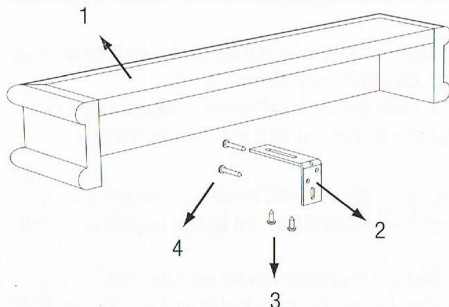

Your wood valance should include the following pieces:

1. Wood valance (with or without returns on each side);

Pieces only for wall mount:

2. Angle bracket (appropriate size)
3. Screw 5/8"
4. Screw 1 1/4"



VERIFICATION OF REQUIRED PIECES

By using the following charts, please make sure your packaging contains the correct quantity of each piece and the correct type of angle bracket.

Valance width	Number of angle brackets	Screw 5/8"	Screw 1 1/4"
47" et under	2	4	4
48" à 83"	3	6	6
84" à 100"	4	8	8
101" and more	5 and more	10 and more	10 and more

Depth of 3" and more

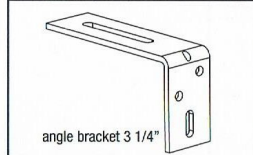

Depth of >1" and < 3"

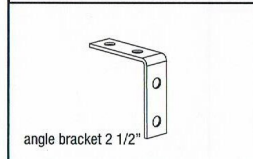

Depth of 1" and under

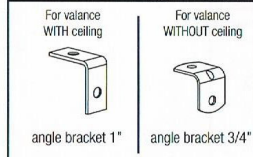

INSTALLATION PROCESS

IMPORTANT: Please refer to the installation instructions of your shade to install it inside the valance.

WALL MOUNT

- Mark with a pen, on the wall the places where you wish to fix an angle bracket;
- By using screws 1 1/4", fix the angle brackets on wall where you made marks.

IMPORTANT: Make sure that angle brackets are all at the same level.

- Place the valance on top of the angle brackets;
- Fix the angle brackets by using screws 5/8".

CEILING MOUNT

- Screw the valance at the wanted places on the ceiling.

INSTALLATION INSTRUCTIONS

PVC VALANCE

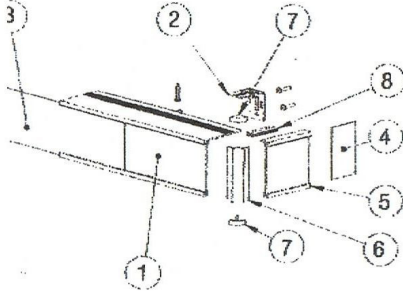

PVC valance should include the following pieces:
 front of the valance;
 brackets (for wall mount only);
 fabric insertion
 PVC plates (2)

as only for valance with returns:
 returns of the valance (2)
 round corners of the valance (2)
 cover of the round corner (4)
 inserts between the front and the return (2)



Valance WITH returns

- A- Remove the adhesive tape that retain the fabric on the back of the valance;
- B- Gather the pieces (see picture 1);
- C- Slide the fabric inside the returns and then to the back of the valance;
- D- Slide a PVC plate on the back of each returns in order to lock the fabric insertion.

⚠ IMPORTANT: the PVC plate is curved. When slid, make sure that the outside of the curved touches the fabric insertion, to make sure that the plate does not move out of the valance (see picture 2).

For a wall mount:

- E- Screw the brackets at the wanted places on the wall (make sure that brackets are all at the same level) (see picture 3);
- F- Install the valance under the leg of the bracket in order to lock the valance (see picture 5).

For a ceiling mount:

- E- Screw directly into the valance at the wanted places of the ceiling (see picture 4).

Picture 3

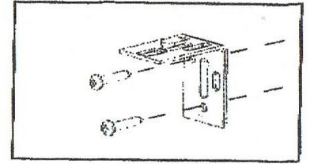

Picture 4

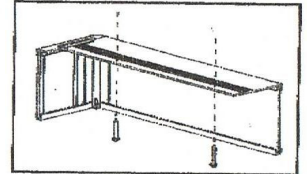

Picture 1

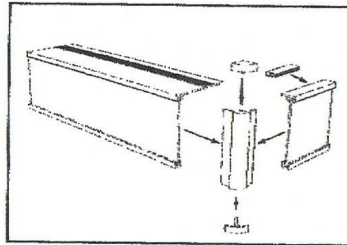

Picture 2

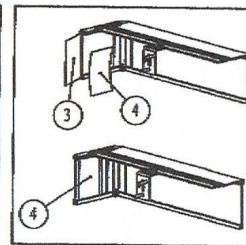

Picture 5

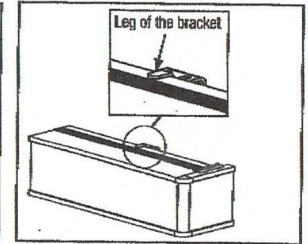

Valance WITHOUT returns

For a wall mount:

- A- Screw the brackets at the wanted places on the wall (make sure that all the brackets are all at the same level);
- B- Install the valance under the leg of the bracket in order to lock the valance (see picture 6).

For a ceiling mount:

- A- Screw directly into the valance at the wanted places of the ceiling (see picture 7).

Picture 6

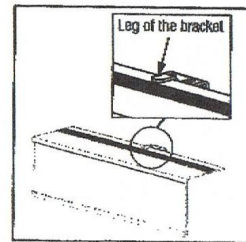

Picture 7

